

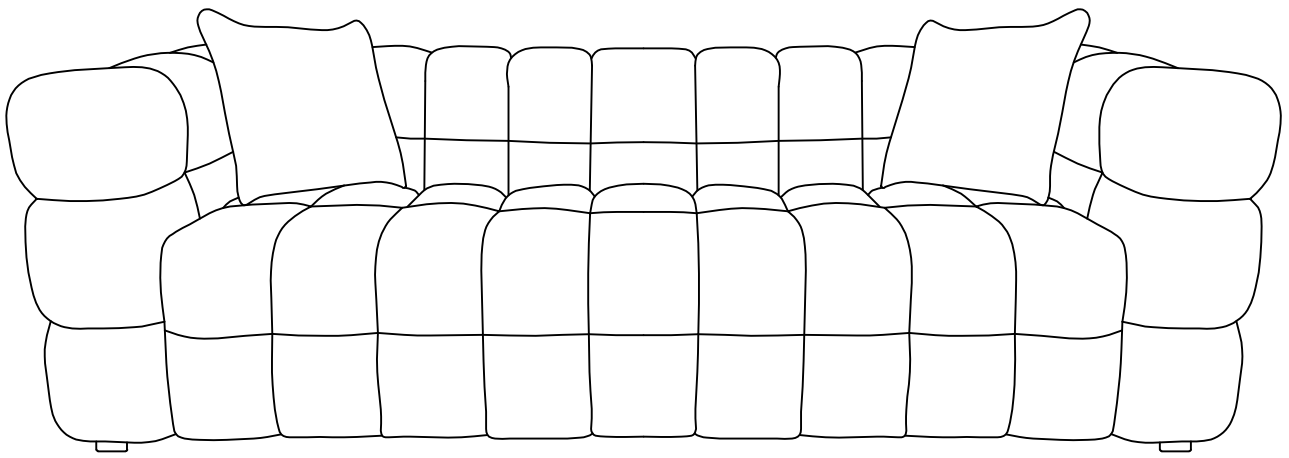

Assembly Instruction

Sofa

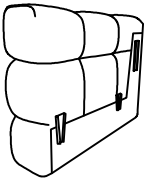
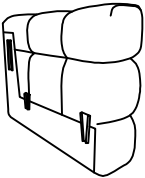
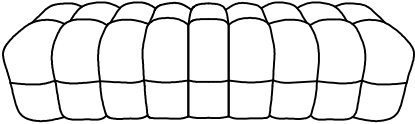
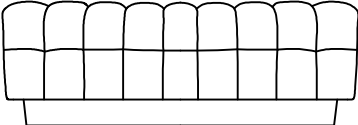
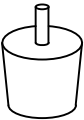

Parts List

Parts List

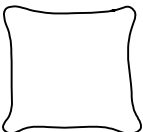
Label	Picture	Description	QTY
AL		Left Armrest	1
AR		Right Armrest	1
B		Seat	1
C		Backrest	1
D		Leg	4
E		Mid-Leg	1
F		Pillow	2

Hardware

Label	Picture	Description	QTY
①		Platic washer	1

Assembly Preparation

Before Beginning
Assembly:

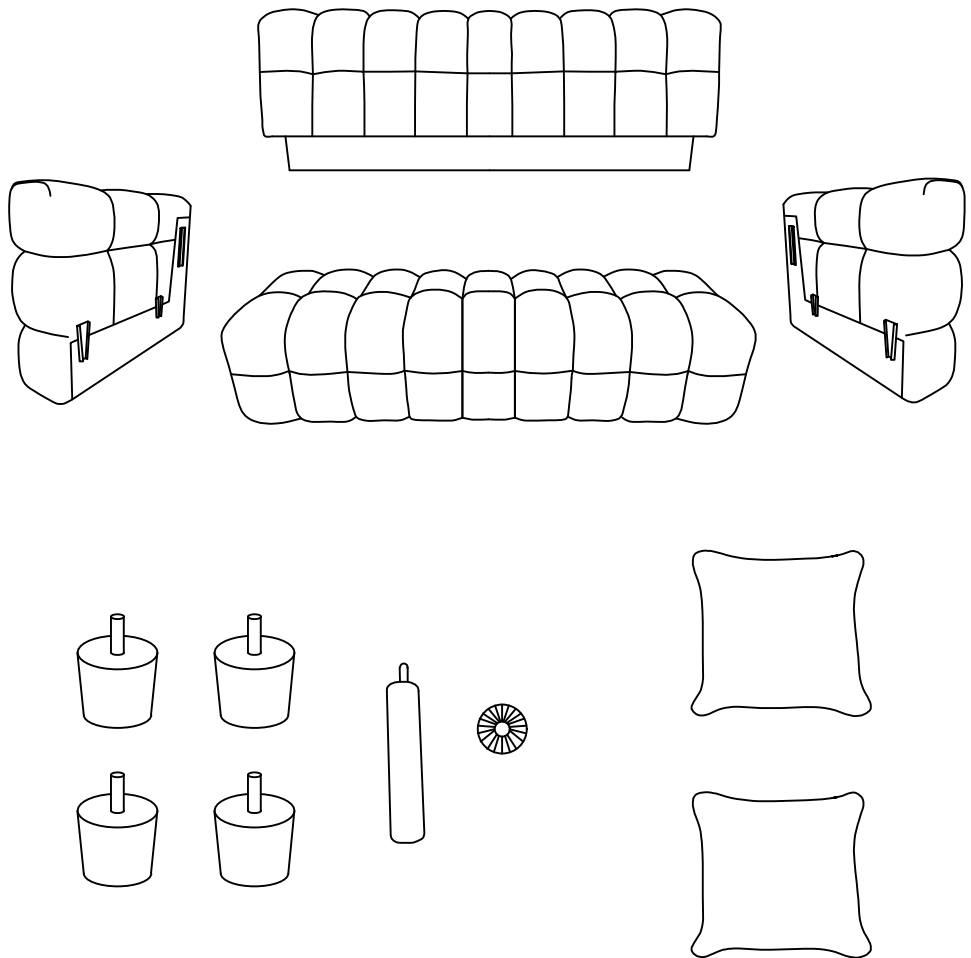

● Read instructions, cover to cover.



● Have 2 adults on hand for assembly.



● Do not assemble on flooring or carpet.



● Assemble on a clean non-marring surface (packing foam).



● Save all packaging until finished.

Step 1

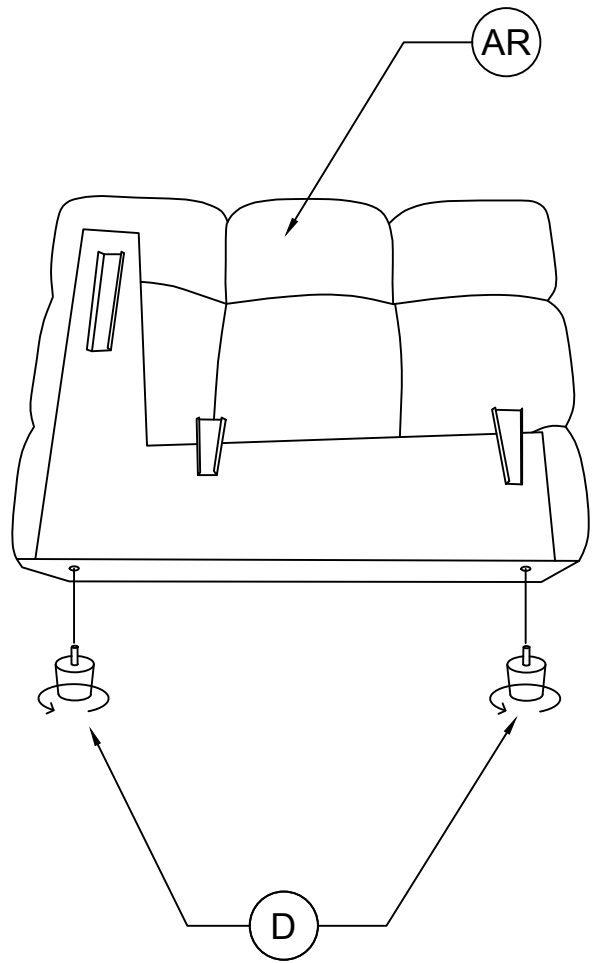
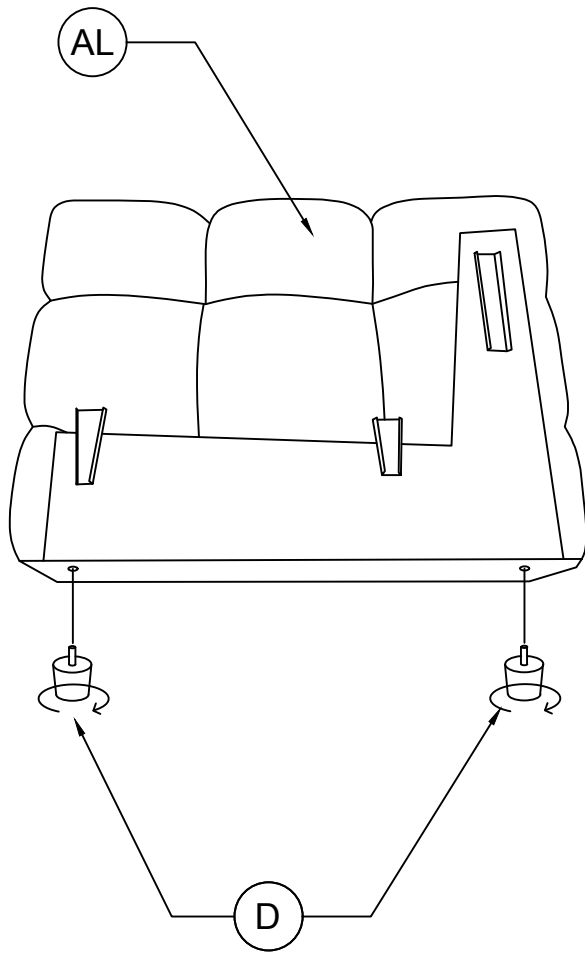

Step2

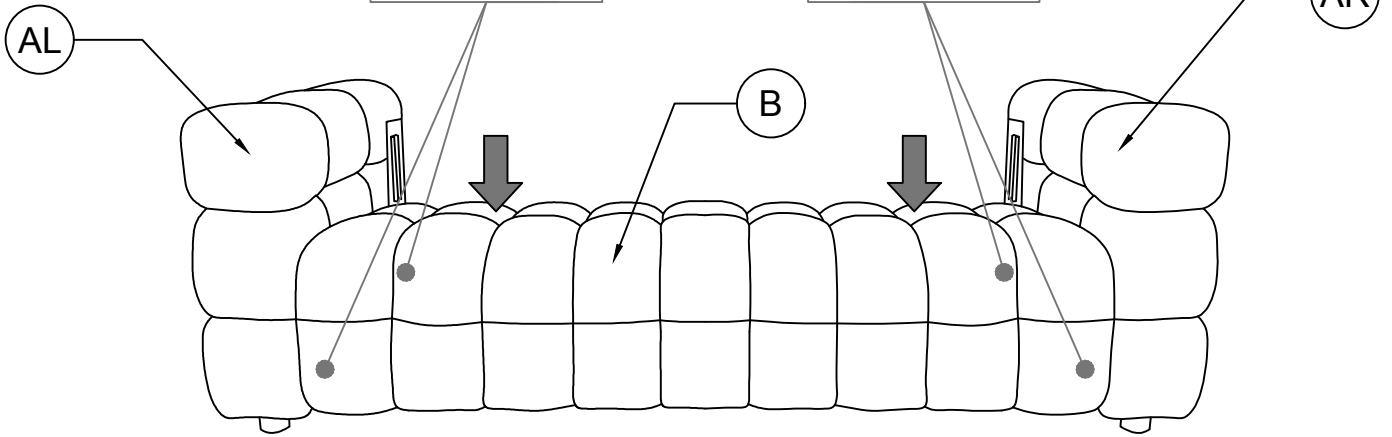
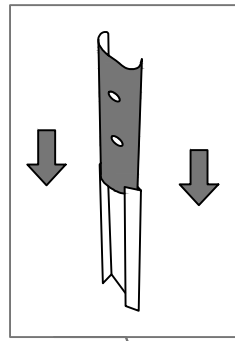
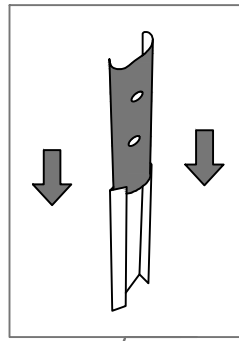
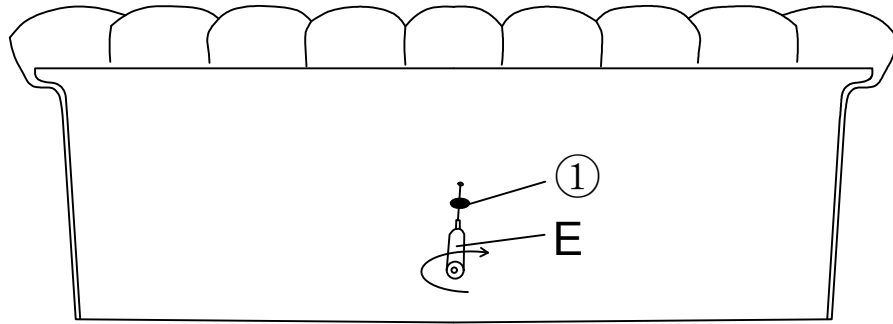
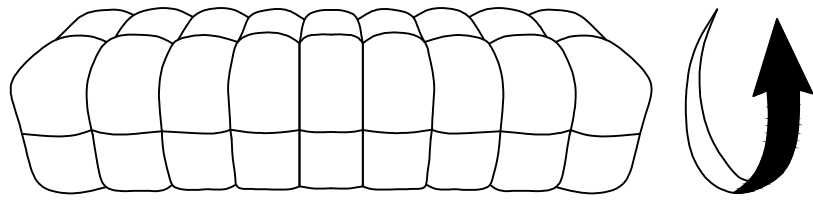

Step3

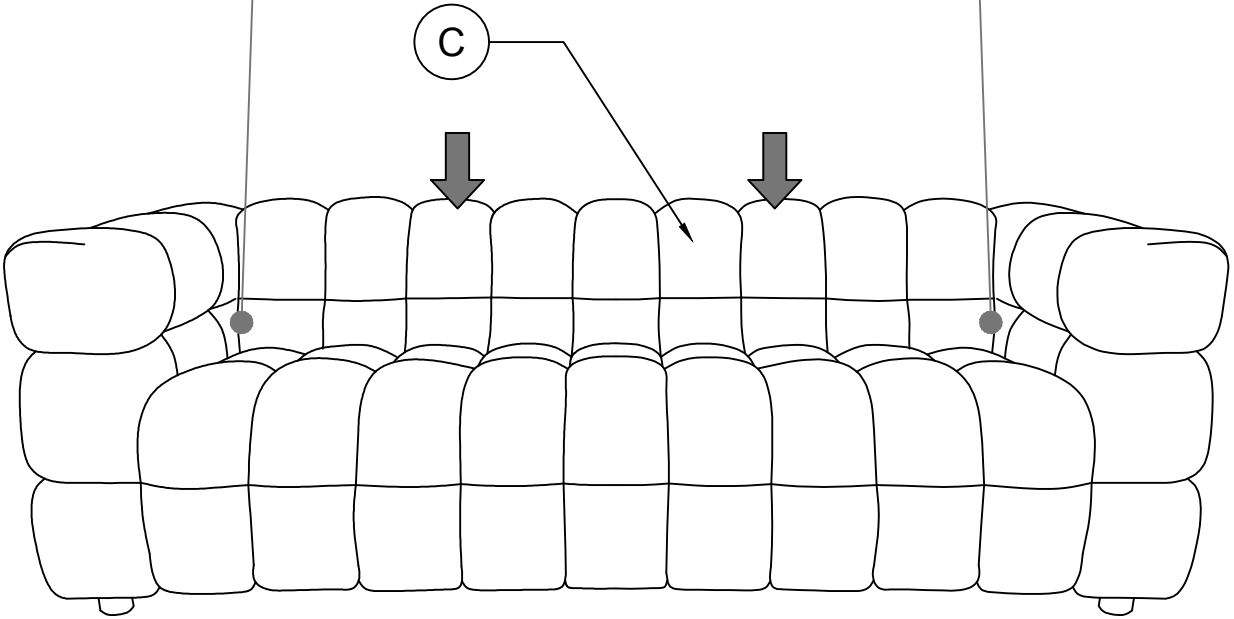
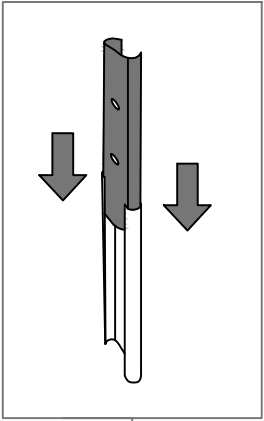
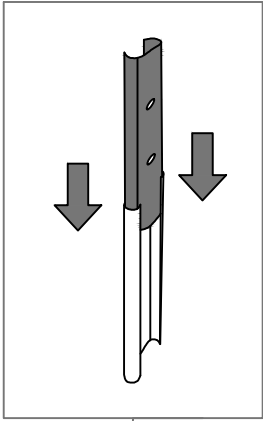

Step3

